



PUBLIC ADDRESS SYSTEM

OPERATION MANUAL

● T-2S01 PRE AMPLIFIER



Please follow the instructions in this manual to obtain the optimum results from this unit.
We also recommend that you keep this manual handy for future reference.

TABLE OF CONTENTS

1. SAFETY PRECAUTIONS	3
2. GENERAL DESCRIPTION	5
3. FEATURES	5
4. NOMENCLATURE AND FUNCTIONS	
4.1 Front Panel	6
4.2 Rear Panel.....	7
5. APPLICATIONS	8
6.SPECIFICATIONS	9
7.BLOCK DIAGRAM	10
8.DIMENSIONAL DIAGRAM	11

1. SAFETY PRECAUTIONS

- Be sure to read the instructions in this section carefully before use.
- Make sure to observe the instructions in this manual as the conventions of safety symbols and messages regarded as very important precautions are included.
- We also recommend you keep this instruction manual handy for future reference.

Safety Symbol and Message Conventions

Safety symbols and messages described below are used in this manual to prevent bodily injury and property damage which could result from mishandling. Before operating your product, read this manual first and understand the safety symbols and messages so you are thoroughly aware of the potential safety



WARNING

Indicates a potentially hazardous situation which, if mishandled, could result in death or serious personal injury.



CAUTION

Indicates a potentially hazardous situation which, if mishandled, could result in moderate or minor personal injury, and/or property damage.



WARNING

When Installing the Unit

- Do not expose the unit to rain or an environment where it may be splashed by water or other liquids, as doing so may result in fire or electric shock.
- Use the unit only with the voltage specified on the unit. Using a voltage higher than that which is specified may result in fire or electric shock.
- Do not cut, kink, otherwise damage nor modify the power supply cord. In addition, avoid using the power cord in close proximity to heaters, and never place heavy objects -- including the unit itself -- on the power cord, as doing so may result in fire or electric shock.
- Be sure to replace the unit's terminal cover after connection completion. Because high voltage is applied to the speaker terminals, never touch these terminals to avoid electric shock.
- Be sure to ground to the safety ground (earth) terminal to avoid electric shock. Never ground to a gas pipe as a catastrophic disaster may result.
- Avoid installing or mounting the unit in unstable locations, such as on a rickety table or a slanted surface. Doing so may result in the unit falling down, causing personal injury and/or property damage.

When the Unit is in Use

- Should the following irregularity be found during use, immediately switch off the power, disconnect the power supply plug from the AC outlet and contact your nearest **ITC** dealer. Make no further attempt to operate the unit in this condition as this may cause fire or electric shock.
 - If you detect smoke or a strange smell coming from the unit.
 - If water or any metallic object gets into the unit
 - If the unit falls, or the unit case breaks
 - If the power supply cord is damaged (exposure of the core, disconnection, etc.)
 - If it is malfunctioning (no tone sounds.)
- To prevent a fire or electric shock, never open nor remove the unit case as there are high voltage components inside the unit. Refer all servicing to your nearest **ITC** dealer.
- Do not place cups, bowls, or other containers of liquid or metallic objects on top of the unit. If they accidentally spill into the unit, this may cause a fire or electric shock.
- Do not insert nor drop metallic objects or flammable materials in the ventilation slots of the unit's cover, as this may result in fire or electric shock.

CAUTION

When Installing the Unit

- Never plug in nor remove the power supply plug with wet hands, as doing so may cause electric shock.
- When unplugging the power supply cord, be sure to grasp the power supply plug; never pull on the cord itself. Operating the unit with a damaged power supply cord may cause a fire or electric shock.
- When moving the unit, be sure to remove its power supply cord from the wall outlet. Moving the unit with the power cord connected to the outlet may cause damage to the power cord, resulting in fire or electric shock. When removing the power cord, be sure to hold its plug to pull.
- Do not block the ventilation slots in the unit's cover. Doing so may cause heat to build up inside the unit and result in fire.
- Avoid installing the unit in humid or dusty locations, in locations exposed to the direct sunlight, near the heaters, or in locations generating sooty smoke or steam as doing otherwise may result in fire or electric shock.

When the Unit is in Use

- Do not place heavy objects on the unit as this may cause it to fall or break which may result in personal injury and/or property damage. In addition, the object itself may fall off and cause injury and/or damage.
- Make sure that the volume control is set to minimum position before power is switched on. Loud noise produced at high volume when power is switched on can impair hearing.
- Do not operate the unit for an extended period of time with the sound distorting. This is an indication of a malfunction, which in turn can cause heat to generate and result in a fire.
- Contact your ITC dealer as to the cleaning. If dust is allowed to accumulate in the unit over a long period of time, a fire or damage to the unit may result.
- If dust accumulates on the power supply plug or in the wall AC outlet, a fire may result. Clean it periodically. In addition, insert the plug in the wall outlet securely.
- Switch off the power, and unplug the power supply plug from the AC outlet for safety purposes when cleaning or leaving the unit unused for 10 days or more. Doing otherwise may cause a fire or electric shock.

An all-pole mains switch with a contact separation of at least 3 mm in each pole shall be incorporated in the electrical installation of the building.

2. GENERAL DESCRIPTION

The T-2S01 series is equipped with pre-amplifier. They are designed to suit all PA system application in schools. Home.offices and stores.

3. FEATURES

CHIME SIGNAL

- 1 Selective two tone/four tone chime(Internal setting)
- 2 Automatic priority
- 3 Permissible external chime remote and p.t.t remote

Master 1,2 output

Two band eq per output

Signal indicator per input

Independent din jack for p.t.t remote

Prioriyt switch and phantom of mic 2,3,4

Selective mic input of h.p.f

Selective output per input signal(output 1,output1+2,output 2)

Independent line input with rca pin jack (line 7~10)

Recording output

Led indicator for master-output

AC/DC 24V

4. NOMENCLATURE AND FUNCTIONS

4.1 FRONT PANEL

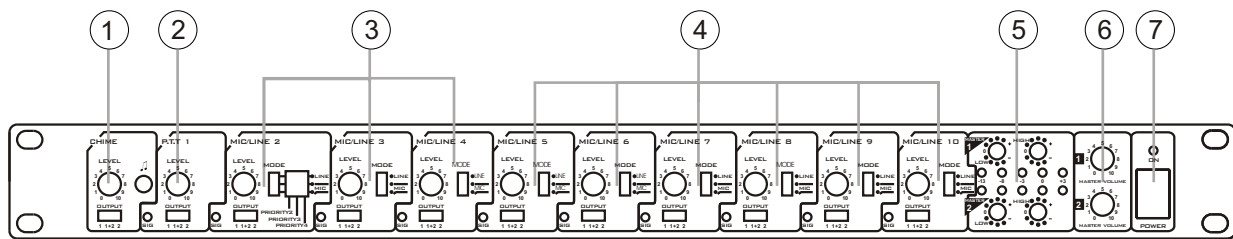

1. CHIME

Pressing chime switch, chime signal will be activated as a pre signal. You can adjust level.

OUTPUT SWITCH

This is for selector that send chime signal to master output. Chime signal has a priority. When chime signal is activated, signal output of input 5~10 will be closed.

⚠ **IMPORTANT NOTICE:** Priority will be given only for selected output.

2. INPUT 1 CONTROLS

Adjust level volume so as not to turn on +3CLIP LED under two~three o'clock of master volume this is control for mic input level.

OUTPUT SWITCH

This is selector that send signal of input 1 to the master output. When input 1 are activated, signal of input 5~10 will be closed.

3. INPUT 2,3,4 CONTROLS

Adjust level volume so as not to turn on +3LED under two~three o'clock of master volume this is control for MIC/LINE input closed.

OUTPUT SWITCH



This is selector that send signal of input 2,3,4 to the master output. When input 2~4 are activated, signal of input 5~10 will be closed.

MODE SWITCH

MIC  : It is input mic switch of 300Hz H.P.F that makes sound clearance. When you select Switch, windy sound.

MIC  : This is MIC input switch Without filter line.

LINE : Line input for CD CASSETTE, TUNER.

IMPORTANT NOTICE: Selecting mode switch “” (HPF), “” (flat) power will be supplied to input XLR connector for condenser mic only. If you connect unbalanced dynamic microphone with them, it may be defaulted and should be moving to mode switch for noise Down.

PRIORITY 2~4

When you switch “on”, priority is activated and will close input 5~10.

4. INPUT 5~10 CONTROLS

These make adjustment of MIC/LINE For input 5~10.

Adjust output level so as not to tune “on” CLIP LED under two o'clock.

OUTPUT SWITCH

This is selector that send signal of input 5~10 to the master output.

When input 1~4 signal and chime signal are supplied, priority will be activated and close output of input 5~10.



This is selector that send signal of input 2,3,4 to the master output when input 2~4 are activated, signal of input 5~10 will be close.

MODE SWITCH

MIC  : It is input mic switch of 300Hz H.P.F that makes sound clearance. When you select Switch, windy sound.

MIC  : This is MIC input switch Without filter line.

LINE : Line input for CD CASSETTE, TUNER.

IMPORTANT NOTICE: Selecting mode switch “” (HPF), “” (flat) power will be supplied to input XLR connector for condenser mic only. If you connect unbalanced dynamic microphone with them, it may be defaulted and should be moving to mode switch for noise Down.

5. EQUALIZER

Adjust low, high if EQ volume According to condition.

6. MASTER 1,2

This is master volume for all input levels you and better use toward two o'clock adjust level before clipping for proper operation.

7. POWER SWITCH

Press to turn ON the power.

Press again to turn the power OFF.

NOMENCLATURE AND FUNCTIONS

4.2 REAR PANEL

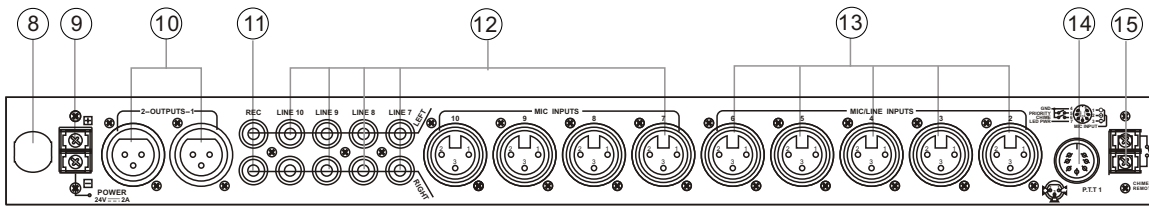

8. AC POWER

Be sure to check AC voltage. Use fuse approved.
IMPORTANT NOTICE: Be sure not to make a short for battery and polarity of battery.

9. DC POWER

DC 24V power input

10. OUTPUTS 1,2

This is master outputs which can be selected by switch.

11. RECORDING

Recording outputs two L, R unbalanced RCA jacks are converted into stereo signals in the internal circuit from mono signal. Recording output volume can not be controlled by master volume controller because circuit of recording output controls is just in the before master volume controls.

12. LINE 7~10

LINE 7~10 unbalanced two L, R RCA jack are converted into mono in the internal circuit all line input -10dB(245mV) input level are for cassette deck, CD, dat deck, tuner.

13. MIC/LINE INPUT 2~6

MIC/LINE balanced input can be selected by mode switch in the front panel.

⚠ **IMPORTANT NOTICE:**

When you select MIC input, operating voltage is only for condenser microphone if you connect dynamic microphone balance by mistake, microphone will be out of work also, be sure not be insert mic input connector under level volume-up, speaker systems may get damage due to big noise.

14. P.T.T. 1

Connect this terminal with T-621 priority and chime controls are activated from T-621(P.T.T remote) and Microphone cable with shield can be extended at the max 30m.

⚠ **IMPORTANT NOTICE:**

Be sure not to make a short to the ground because microphone signal +, - is for operating power of condenser microphone.

15. CHIME REMOTE TERMINAL

This is a terminal for chime signal.

5. APPLICATIONS

REAR PANEL CONNECTIONS

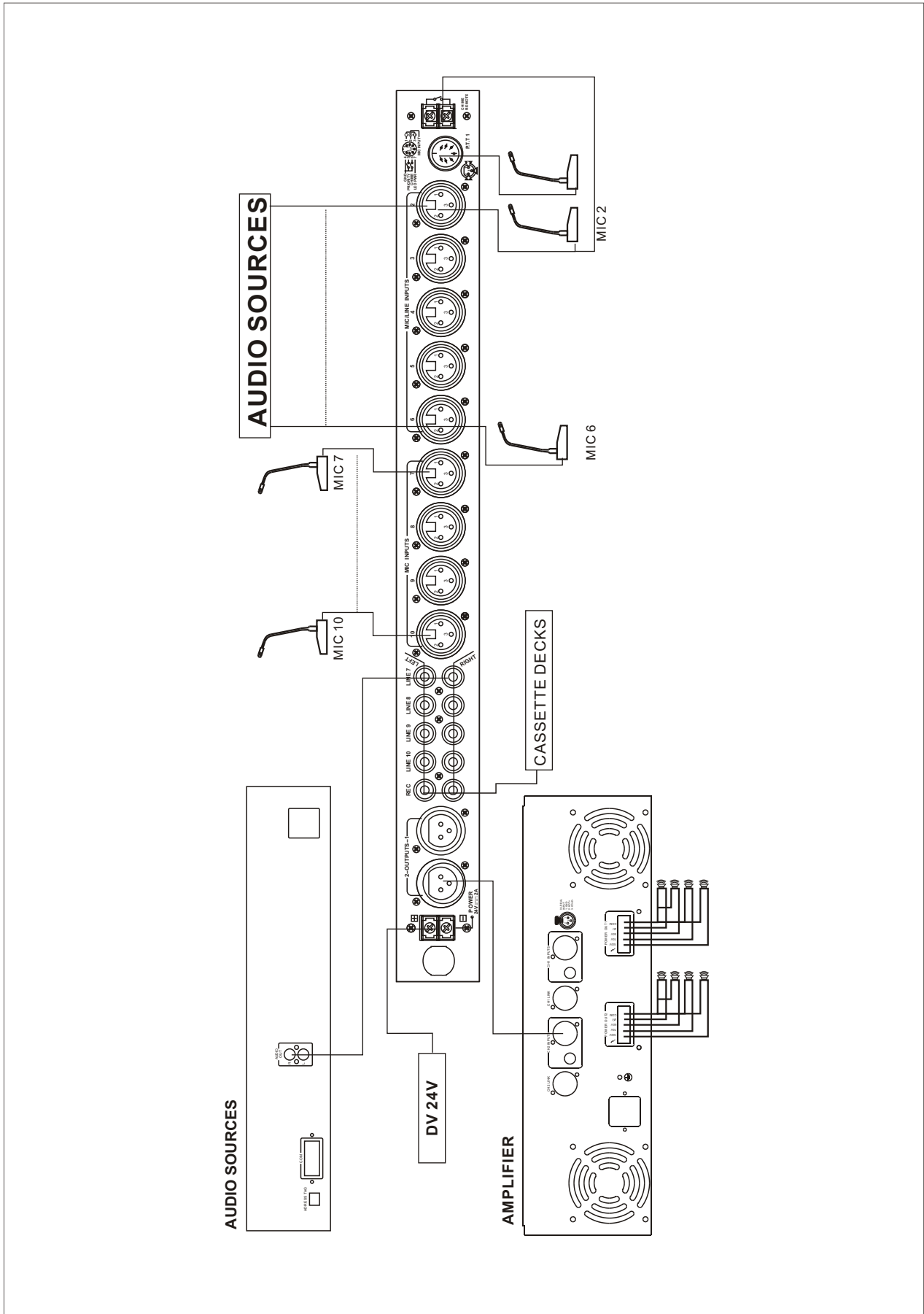

6. SPECIFICATIONS

PRE-AMPLIFIER	
MODEL	T-2S01
INPUT SENSITIVITY/IMPEDANCE	MIC/LINE: -5dBu(2.45mV)/5Kohms BAL -10dBu(245mV)/5Kohms BAL LINE RCA IN:-10dBu(245mV)/10Kohms UNBAL
OUTPUT LEVEL/IMPEDANCE	MASTER 1,2:NOR +4dBu(21.23V)/200ohms BAL REC: NOR 0dBu(0.775mV)/10K Ω UNBAL
OUTPUT LEVEL/IMPEDANCE	MASTER 1,2:NOR +4dBu(21.23V)/200ohms BAL REC: NOR 0dBu(0.775mV)/10K Ω UNBAL
FREQUENCY RESPONSE	Less Than -0.5dB(20Hz~20KHz)
SIGNAL TO NOISE RATIO	MIC: MORE THAN 60dB LINE: MORE THAN 0.03%
CROSS-TALK	MIC:MORE THAN 60dB LINE:MORE THAN 75dB
POWER CONSUMPTION	13W
POWER CONSUMPTION	~ 220-240V 50/60Hz (Option)
DIMENSION(mm)	484X378X45
NET WEIGHT	5.52Kg
GROSS WEIGHT	6.65Kg

7. BLOCK DIAGRAM

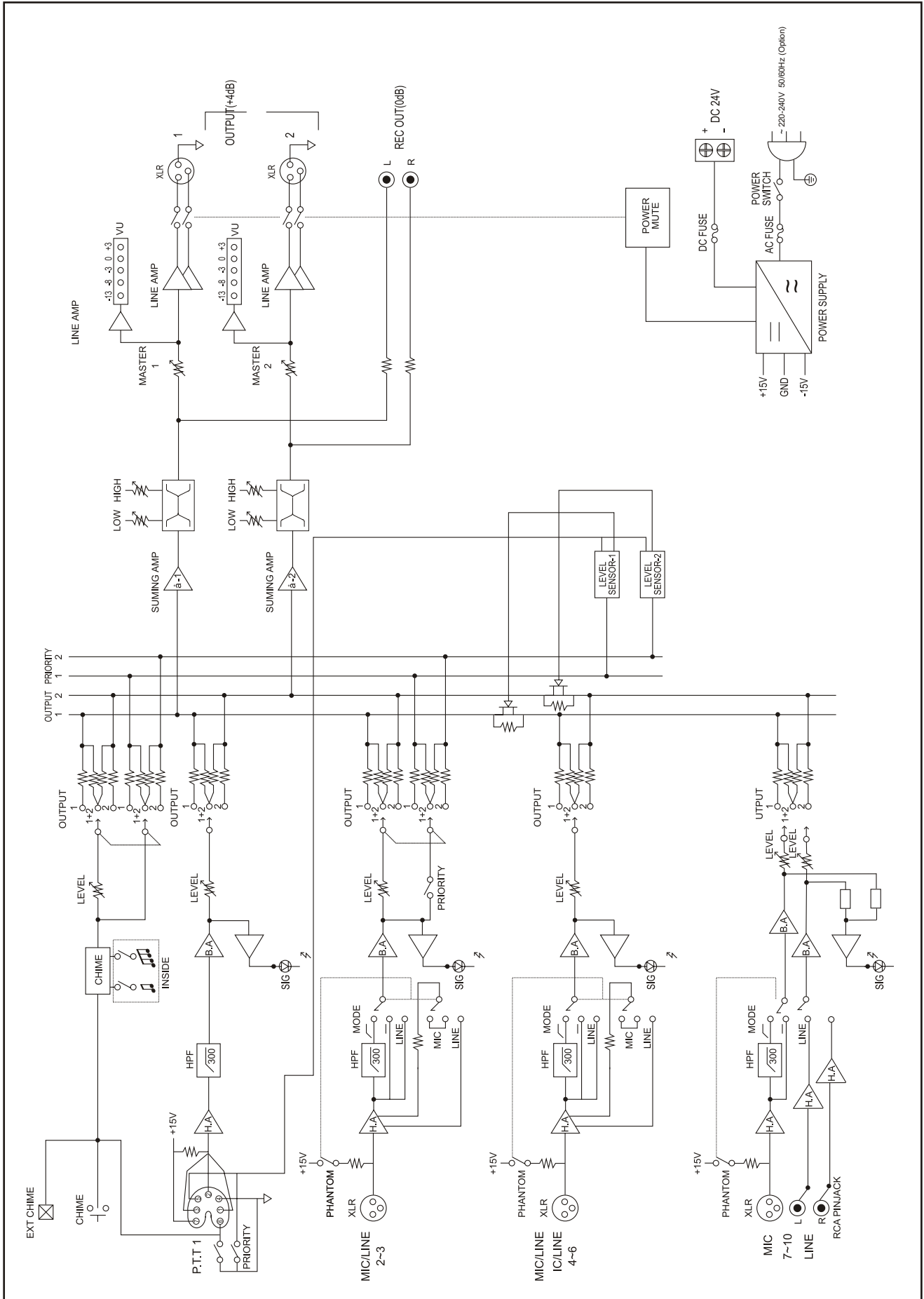

8. DIMENSIONAL DIAGRAM

UNIT:mm

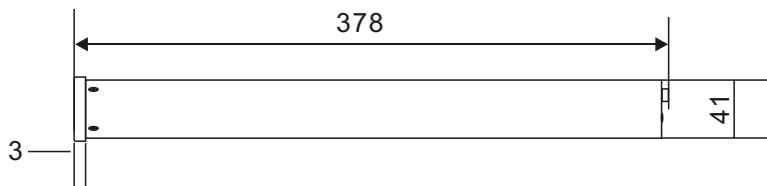
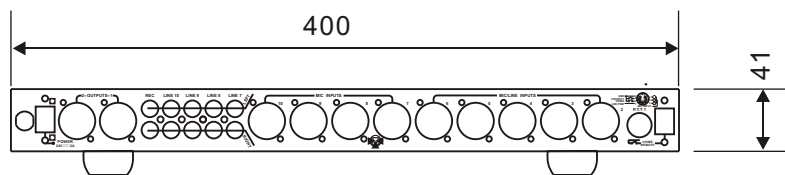
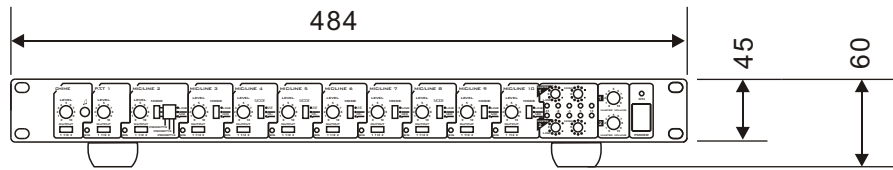

Keep the unit's all sides over 10 cm away from objects that may obstruct air flow to prevent the unit's internal temperature rise.

UNIT:mm

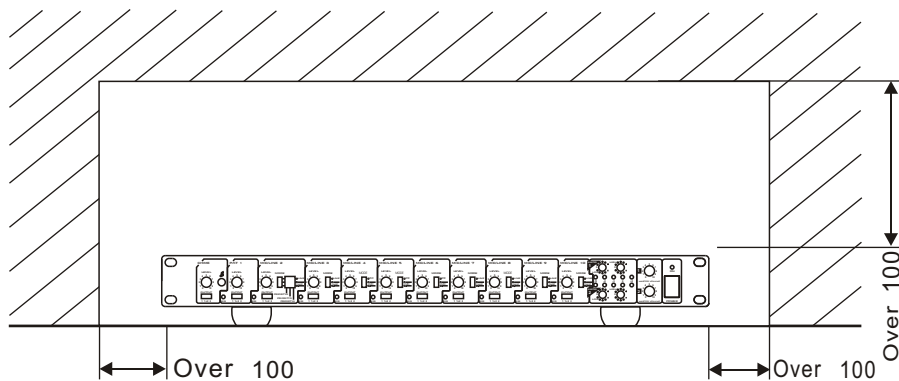

PROFESSIONAL PUBLIC ADDRESS SYSTEM

