

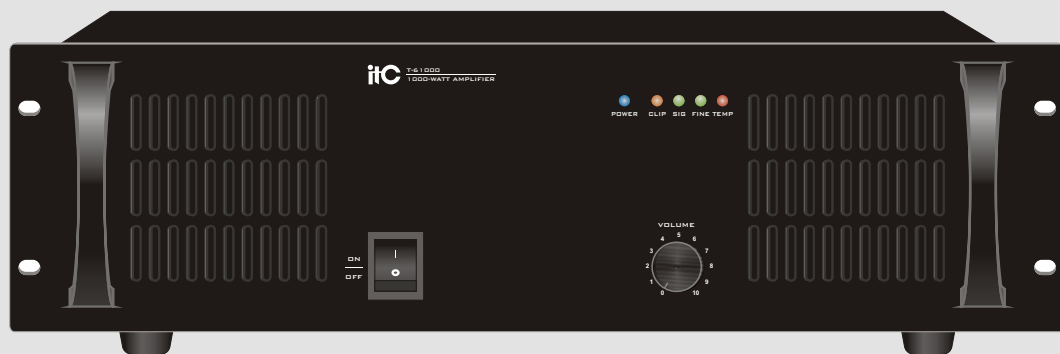

PUBLIC ADDRESS SYSTEM

OPERATION MANUAL

T-61000
T-61500
1000/1500-WATT AMPLIFIER



Please follow the instructions in this manual to obtain the optimum results from this unit.
We also recommend that you keep this manual handy for future reference.

TABLE OF CONTENTS

1. SAFETY PRECAUTIONS	3
2. GENERAL DESCRIPTION	5
3. FEATURES	5
4. NOMENCLATURE AND FUNCTIONS	
4.1 Front Panel	6
4.2 Rear Panel	7
5. CONNECTIONS	
5.1 Speaker Connections	8
5.2 XLR Connections	8
6. APPLICATIONS	9
7. BLOCK DIAGRAM	10
8. SPECIFICATIONS	11
9. DIMENSIONAL DIAGRAM	12

1. SAFETY PRECAUTIONS

- Be sure to read the instructions in this section carefully before use.
- Make sure to observe the instructions in this manual as the conventions of safety symbols and messages regarded as very important precautions are included.
- We also recommend you keep this instruction manual handy for future reference.

Safety Symbol and Message Conventions

Safety symbols and messages described below are used in this manual to prevent bodily injury and property damage which could result from mishandling. Before operating your product, read this manual first and understand the safety symbols and messages so you are thoroughly aware of the potential safety



WARNING

Indicates a potentially hazardous situation which, if mishandled, could result in death or serious personal injury.



CAUTION

Indicates a potentially hazardous situation which, if mishandled, could result in moderate or minor personal injury, and/or property damage.



WARNING

When Installing the Unit

- Do not expose the unit to rain or an environment where it may be splashed by water or other liquids, as doing so may result in fire or electric shock.
- Use the unit only with the voltage specified on the unit. Using a voltage higher than that which is specified may result in fire or electric shock.
- Do not cut, kink, otherwise damage nor modify the power supply cord. In addition, avoid using the power cord in close proximity to heaters, and never place heavy objects -- including the unit itself -- on the power cord, as doing so may result in fire or electric shock.
- Be sure to replace the unit's terminal cover after connection completion. Because high voltage is applied to the speaker terminals, never touch these terminals to avoid electric shock.
- Be sure to ground to the safety ground (earth) terminal to avoid electric shock. Never ground to a gas pipe as a catastrophic disaster may result.
- Avoid installing or mounting the unit in unstable locations, such as on a rickety table or a slanted surface. Doing so may result in the unit falling down, causing personal injury and/or property damage.

When the Unit is in Use

- Should the following irregularity be found during use, immediately switch off the power, disconnect the power supply plug from the AC outlet and contact your nearest **ITC** dealer. Make no further attempt to operate the unit in this condition as this may cause fire or electric shock.
 - If you detect smoke or a strange smell coming from the unit.
 - If water or any metallic object gets into the unit
 - If the unit falls, or the unit case breaks
 - If the power supply cord is damaged (exposure of the core, disconnection, etc.)
 - If it is malfunctioning (no tone sounds.)
- To prevent a fire or electric shock, never open nor remove the unit case as there are high voltage components inside the unit. Refer all servicing to your nearest **ITC** dealer.
- Do not place cups, bowls, or other containers of liquid or metallic objects on top of the unit. If they accidentally spill into the unit, this may cause a fire or electric shock.
- Do not insert nor drop metallic objects or flammable materials in the ventilation slots of the unit's cover, as this may result in fire or electric shock.

CAUTION

When Installing the Unit

- Never plug in nor remove the power supply plug with wet hands, as doing so may cause electric shock.
- When unplugging the power supply cord, be sure to grasp the power supply plug; never pull on the cord itself. Operating the unit with a damaged power supply cord may cause a fire or electric shock.
- When moving the unit, be sure to remove its power supply cord from the wall outlet. Moving the unit with the power cord connected to the outlet may cause damage to the power cord, resulting in fire or electric shock. When removing the power cord, be sure to hold its plug to pull.
- Do not block the ventilation slots in the unit's cover. Doing so may cause heat to build up inside the unit and result in fire.
- Avoid installing the unit in humid or dusty locations, in locations exposed to the direct sunlight, near the heaters, or in locations generating sooty smoke or steam as doing otherwise may result in fire or electric shock.

When the Unit is in Use

- Do not place heavy objects on the unit as this may cause it to fall or break which may result in personal injury and/or property damage. In addition, the object itself may fall off and cause injury and/or damage.
- Make sure that the volume control is set to minimum position before power is switched on. Loud noise produced at high volume when power is switched on can impair hearing.
- Do not operate the unit for an extended period of time with the sound distorting. This is an indication of a malfunction, which in turn can cause heat to generate and result in a fire.
- Contact your **ITC** dealer as to the cleaning. If dust is allowed to accumulate in the unit over a long period of time, a fire or damage to the unit may result.
- If dust accumulates on the power supply plug or in the wall AC outlet, a fire may result. Clean it periodically. In addition, insert the plug in the wall outlet securely.
- Switch off the power, and unplug the power supply plug from the AC outlet for safety purposes when cleaning or leaving the unit unused for 10 days or more. Doing otherwise may cause a fire or electric shock.

An all-pole mains switch with a contact separation of at least 3 mm in each pole shall be incorporated in the electrical installation of the building.

2. GENERAL DESCRIPTION

Heavy-duty public address power amplifiers deliver clean audio power from 1000 to 1500 watts RMS with less than 0.5% distortion.

Rugged and overbuilt to provide years of reliable service they are equipped with toroidal transformers, extensive heat-sinking, forced fan cooling and protective circuits against short-circuit, clipping and over-temperature.

3. FEATURES

Rated outputs : 1000W and 1500W.

100V/70V constant voltage outputs and 4~16 ohms constant resistance outputs.

Commercial-grade toroidal transformers produce high performance audio on a wide range of frequencies with minimal noise and high fidelity, even at high volume.

Intelligent limiter can reduce excess signal.

Reliable protection against overload, short circuit, and power fluctuation for optimum reliability.

Heat sinks and fan protect against overheating, protecting the amplifiers working life.

Rubber feet and rack mount ears-may be placed on tables or installed in rack mount cabinets.

4. NOMENCLATURE AND FUNCTIONS

4.1 FRONT PANEL

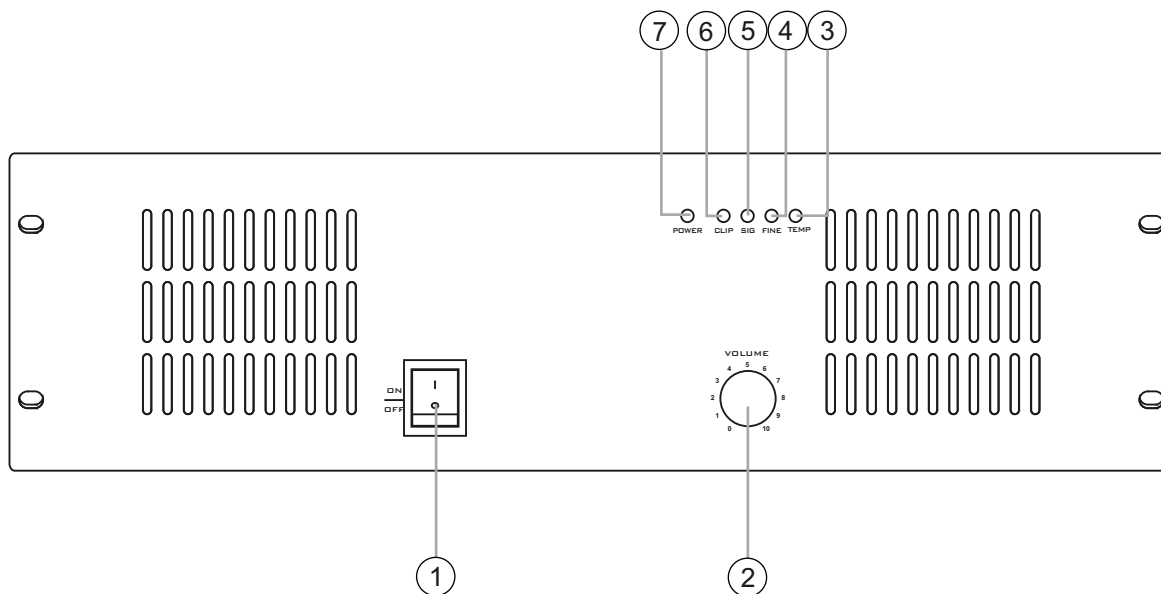

1. POWER SWITCH

On top of the opening Power
Press the end, power shut down

2. VOLUME

Channel volume control

3. TEMP

Temp lit when over heat

4. FINE

Operation indicator

Light indicates normal

5. SIGNAL

Signal indicator LED

When detected input signal.

6. CLIP

Clip lit when max wattage output & output
signal distortion.

7. POWER

Power indicator LED

NOMENCLATURE AND FUNCTIONS

4.2 REAR PANEL

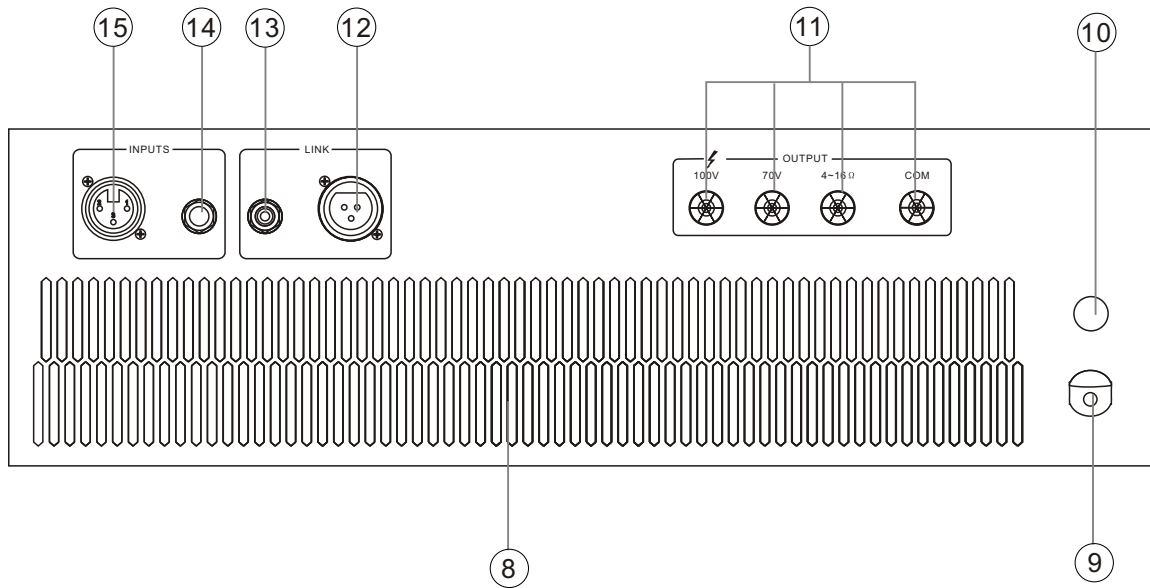

8. FAN

9. AC POWER INPUT

10.FUSE CASE

11.COMMON SPEAKER OUTPUT

Connectors for 4~16 ohms or 70V and 100V speaker

12.LINK LEVE OUTPUT (XLR)

Select only one connection from 12 or 13

13.LINK LEVE OUTPUT (6.3mm)

Select only one connection from 12 or 13

14.MONO AUDIO INPUT (6.3mm)

Select only one connection from 14 or 15

15.MONO AUDIO INPUT (XLR)

Select only one connection from 14 or 15

5. CONNECTIONS

5.1 SPEAKER CONNECTIONS

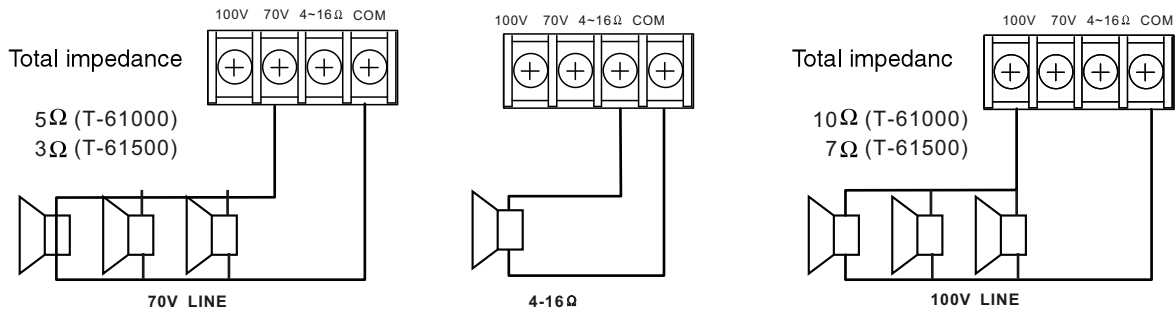

Notes

- Both the 4~16Ω and 70V/100 V terminals cannot be used at the same time.
- Impedances indicated in the figures represent the total speaker system (load) impedances.

WARNING

Be sure to attach the supplied terminal cover after connection completion. Because high voltage is applied to the speaker terminals, never touch these terminals to avoid electric shock.

5.2 XLR CONNECTIONS

Combined XLR (female)/phone jack connectors.

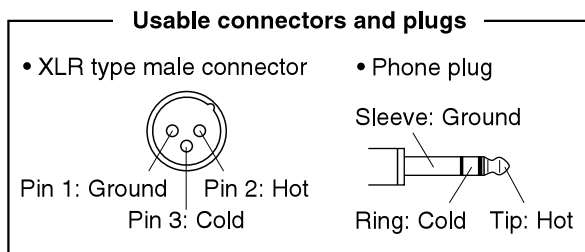

6. APPLICATIONS

REAR PANEL CONNECTIONS

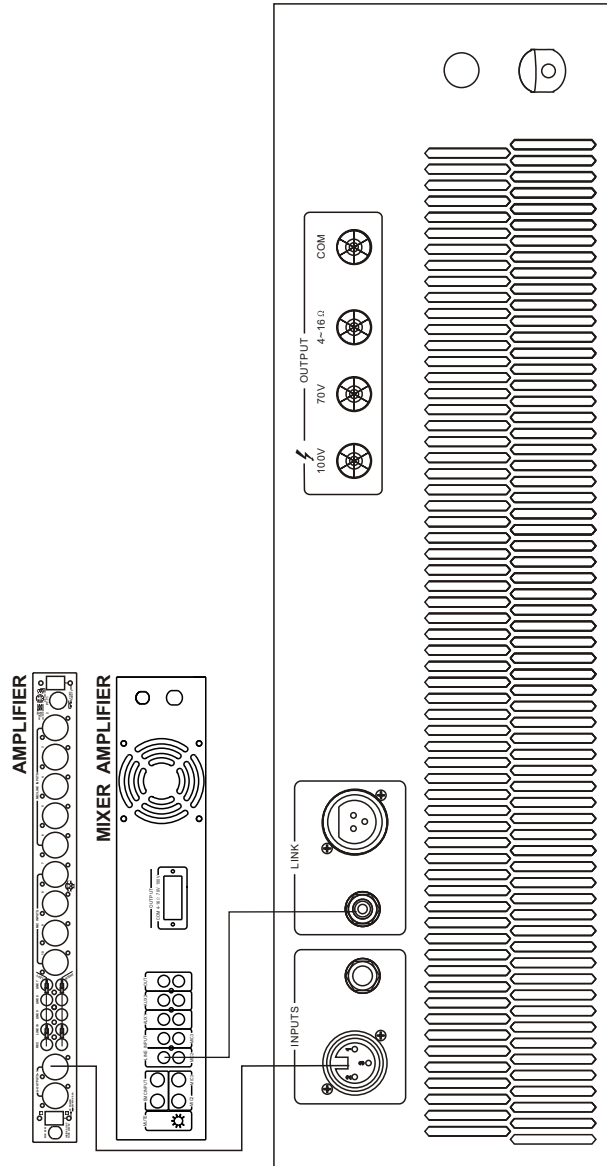

7. BLOCK DIAGRAM

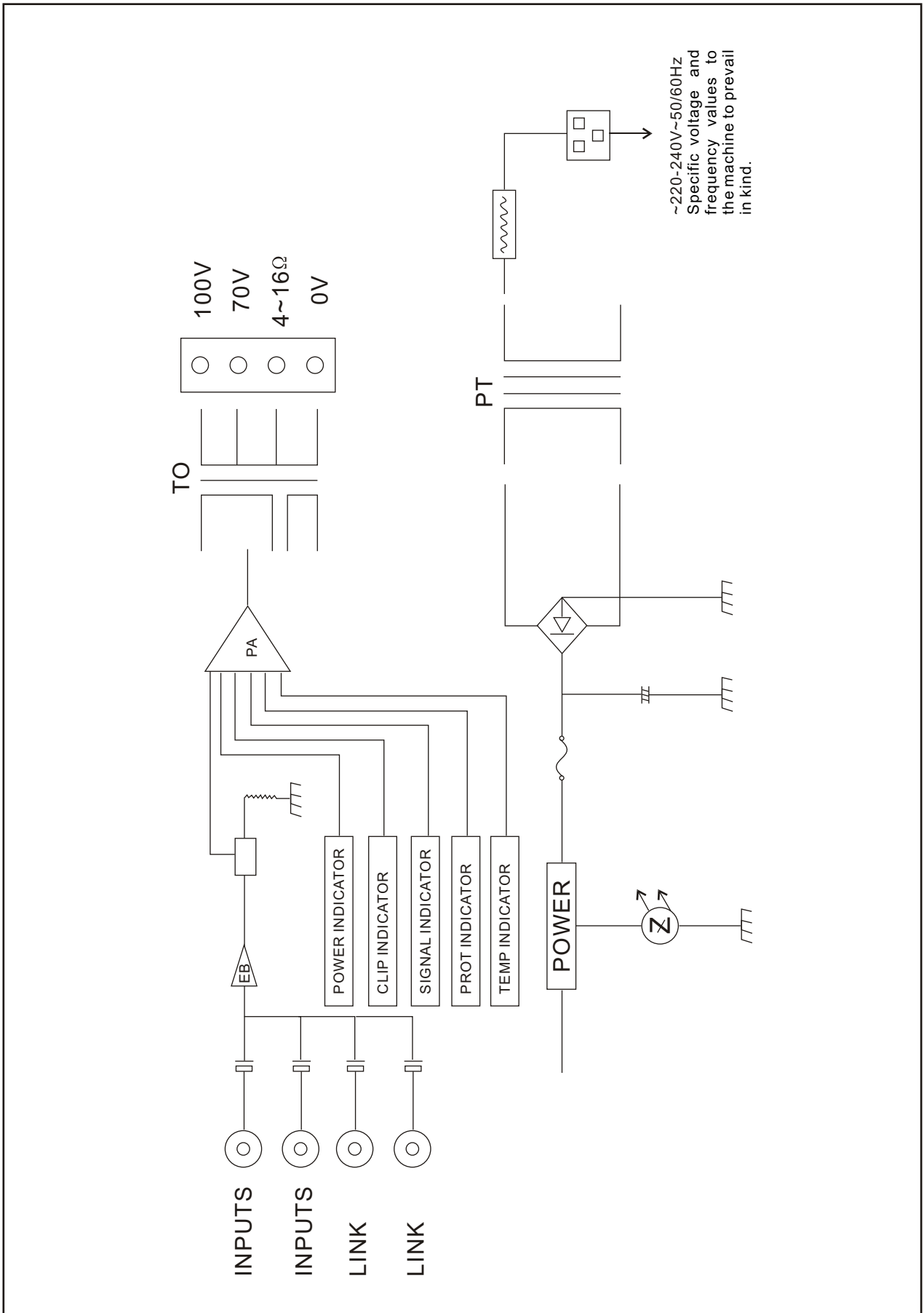

8. SPECIFICATIONS

MODEL	T-61000	T-61500
RATED POWER OUTPUT	1000W	1500W
SPEAKER OUTPUTS	4~16 Ω ,70V/100V	
INPUT SENSITIVITY	1V/0dB	
EQUIVALENT INPUT NOISE	-95dB	
IMPEDANCE COEFFICIENT	200:1	
COMMON-MODE REJECTION	\geq 95dB	
FREQUENCY RESPONSE	90Hz~20KHz \pm 3dB	
S/N RATIO	>15V/microsecond	
T.H.D	<1%	
COOLING MODE	Air Cooling	
INDICATORS	Power, clipping , Signal , Protection and Overheat	
PROTECTION	Power , Overheat , Overload and Short Circuit	
POWER REQUIREMENTS	~220-240V 50/60Hz Specific voltage and frequency values to the machine to prevail in kind.	
POWER CONSUMPTION	1500W	2300W
DIMENSION(MM)	484X406X132	
NET WEIGHT	27Kg	31Kg
GROSS WEIGHT	28.5Kg	32.5Kg

9. DIMENSIONAL DIAGRAM

UNIT :mm

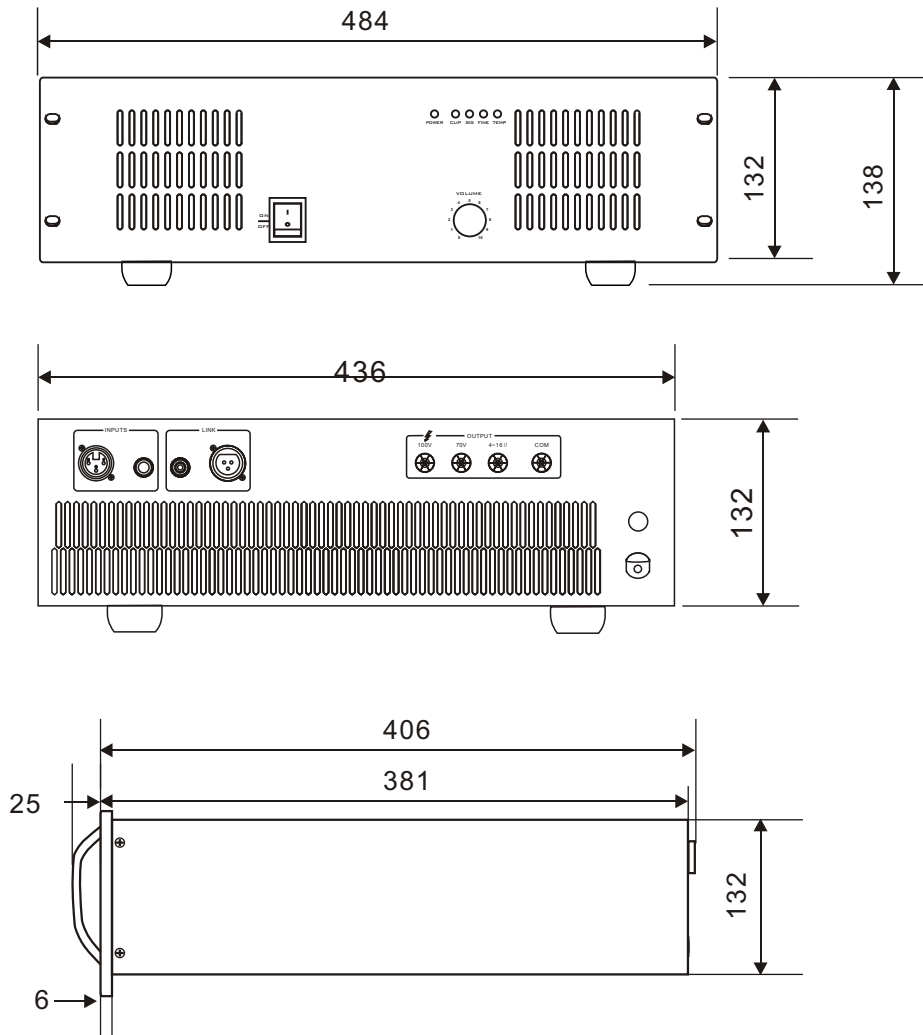

Keep the unit's all sides over 10 cm away from objects that may obstruct air flow to prevent the unit's internal temperature rise.

UNIT :mm

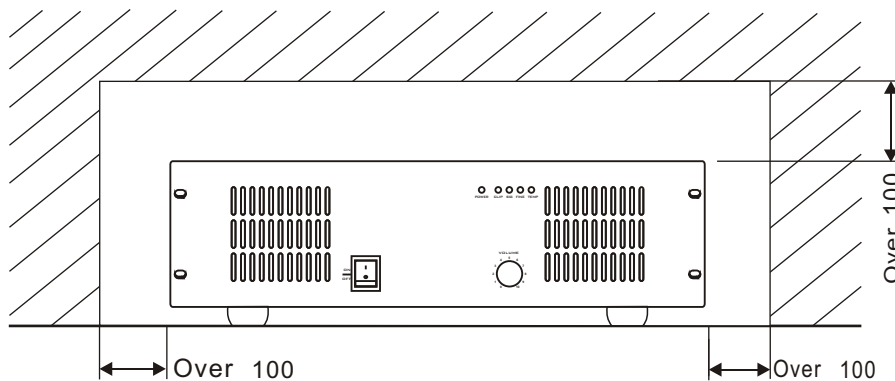

PUBLIC ADDRESS SYSTEM

