

Descriptions

The TI-5 series 5 zone mixer amplifiers are 3U mixer amplifier featuring 70V, 100V and 4-16ohm speaker outputs & 4 universal combined mic inputs of 1/4" phone jack and XLR type. 2 line inputs by dual RCA type are also provided.

The uniqueness of this amplifier is that the 5 zone outputs with separate volume control, which provide flexible zone control. Each 6 inputs are equipped with bass/treble tone controls.

A remote 5 zone paging console T-318 is provided for announcement and control from another location.

Master, Mic1-4, line1-2 volume control & 6 separate treble/bass tone control for each input are provided, along with mic 1 of priority over other inputs. Each channel input with separate treble and bass control.

Built-in siren for fire alarm system, EMC input, built-in chime, 2/4 tone chime selector, chime remote trigger. The TEL input could be used as telephone paging system over PA system.

The REC output for tape recorder and PRE output, AMP input for adding extra signal processor like mixer, graphic equalizer.

Complete protection includes short circuit and thermal protection, current limiter and overloading.

Features

- * 7 inputs 5 zone mixer amplifier
- * Rack mount amplifier in 3U type
- * Rated power output 120W, 240W, 350W and 500W
- * 70V, 100V and 4-16ohm speaker terminals
- * 5 zone 100V outputs and all zones outputs
- * 4 balanced combined mic inputs of 1/4" phone jack and XLR type with separate gain control and phantom power switch
- * 2 dual RCA line inputs, TEL and EMC input
- * Each zone speaker output with separate volume control
- * Remote paging console T-318 for zone paging control
- * Built-in siren and 2/4 tone chime
- * Volume control over master, Mic1-4, Line1-2, chime, siren, all zone output and each 5 zone output, tel input and remote paging mic
- * 5 levels of input priority from high to low: EMC input, tel input, remote paging console, Mic1, siren/chime over other inputs
- * REC output for tape recorder
- * PRE Output and AMP input for extra signal processor
- * AC 110V or 220V and DC 24V operation

Specifications

Model	TI-350S	
Amplifier Section (4Ω Load Output)	Rated Output Power (THD 1%)	350W(RMS)
	Speaker Zone 1~5 Output	70W MAX
Mic Input Section (Mic 1~4 In@1KHz)	Input Sensitivity/Impedance	5mV 600Ω -245mV 5KΩ BAL
	S/N Ratio	Better than 55dB
	Frequency Response (±3dB)	50~20,000Hz
	Tone Control (Bass:100Hz, Treble:10KHz)	±10dB
	Phantom Power	+48V
Line Input Section (Mic 1~2 In@1KHz)	Input Sensitivity/Impedance	350mV/47KΩ
	S/N	Better than 65dB
	Frequency Response (±3dB)	50~20,000Hz
	Tone Control (Bass: 100Hz, Treble:10KHz)	±10dB
Tel Audio Input	Input Sensitivity/Impedance	0.775V/10KΩ
	S/N	Better than 65dB
	Frequency Response (±3dB)	50~20,000Hz
EMC Audio Input	Input Sensitivity/Impedance	0.775V/10KΩ
	S/N	Better than 65dB
	Frequency Response (±3dB)	50~20,000Hz
Pre Amp Out(Mic 1~4, Line 1~2, Tel In, Remote In)	1V/600Ω	
Remote MIC Sensitivity/Impedance	775mV/10KΩ	
THD	Less than 0.1% at 1KHz, 1/3 rated power	
Power Supply	~110V/60Hz or ~230V/50Hz & DC 24V	
Power Consumption	500W	
Weight	22.4Kg	
Dimensions	484x399x132 mm	

Rear Panel TI-350S

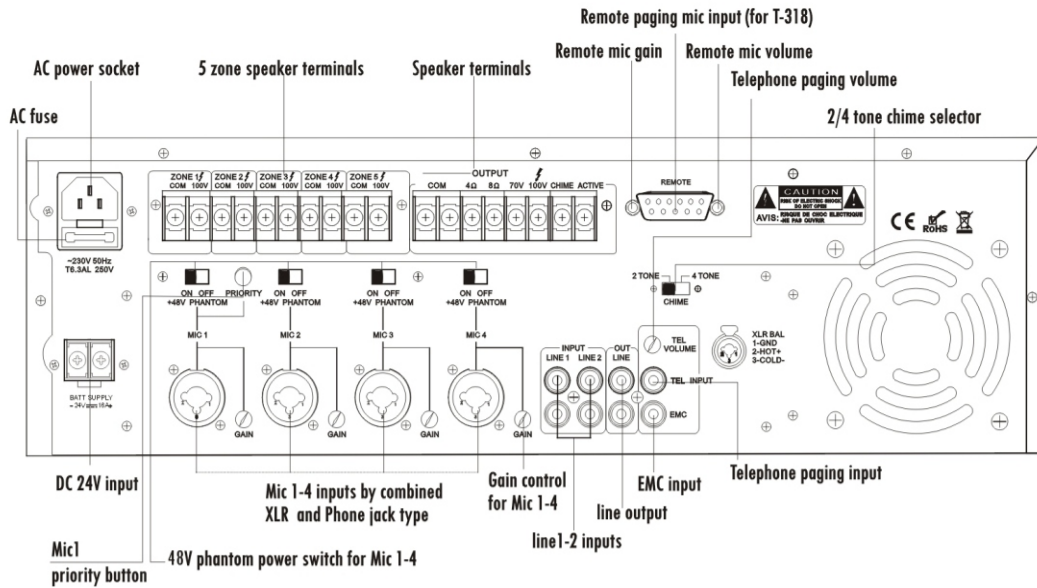

Connections

